

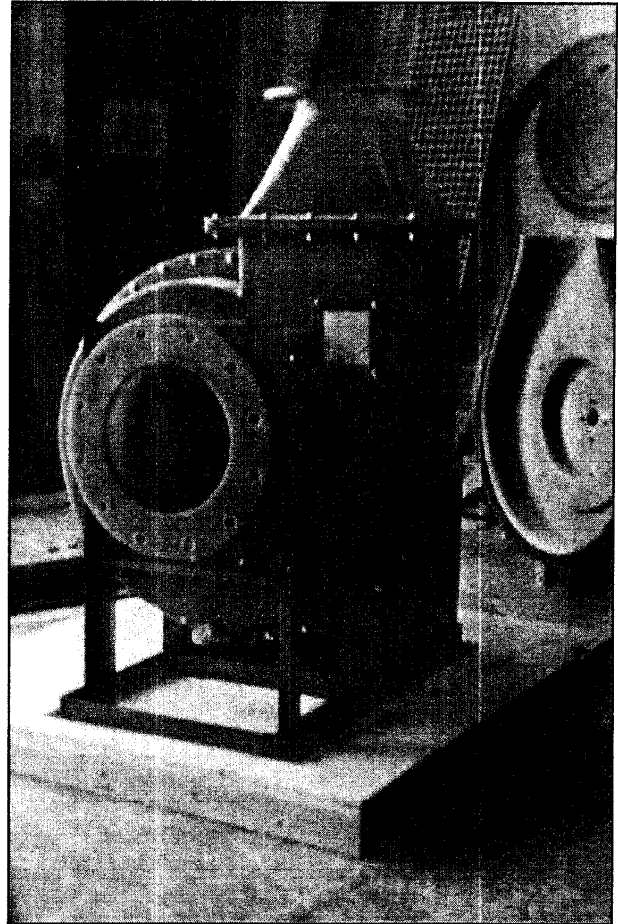

Plasticair MPA Series Centrifugal Fans Heavy Duty Industrial Applications

Features:

- 15 Sizes
- Volumes from 200 cfm to 130,000 cfm
- Pressures to 18" swg
- Heavy duty housing, solid FRP
- Choice of premium vinylester, or polyester resins
- All fixing bolts 316 stainless steel
- All gas contact parts, solid FRP
- All bearings rated for B10 life
- Threaded drain included
- Drive arrangements either 1, 9, or 10
- Bolted centre split fan casing, any rotation



Wheel construction:

- Radial
- Solid FRP, extra heavy duty
- FRP encapsulated metal hub and shaft in airstream
- Self cleaning design
- Edges lined with abrasion resistant synthetic veil

PLASTICAIR INC. CERTIFIES THAT THE MPA SERIES INDUSTRIAL EXHAUST FANS SHOWN HEREIN ARE LICENSED TO BEAR THE AMCA SEAL. THE RATINGS SHOWN ARE BASED ON TESTS AND PROCEDURES PERFORMED IN ACCORDANCE WITH AMCA PUBLICATION 211 AND COMPLY WITH THE REQUIREMENTS OF THE AMCA CERTIFIED RATINGS PROGRAM.

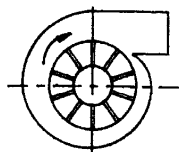

RADIAL BLADE. Less efficient than the B.I. but having the strongest construction, ideal for heavy duty industrial process applications & material handling. Highest pressure capability, self cleaning. Good curve stability.

Plasticair Model

60 MPA shown to the right is constructed to withstand the most severe corrosive applications found in industry. This fan is capable of 18" static pressure and volumes up to 130,000 cfm.

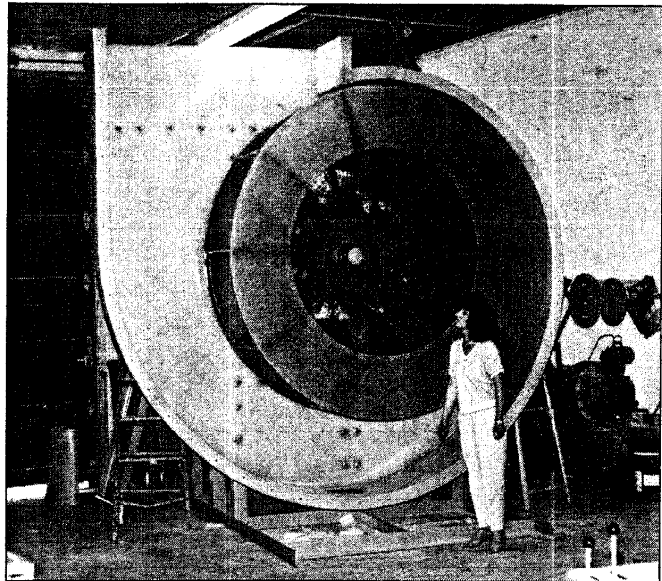

MPA Series General Dimensions

PLASTICAIR INC

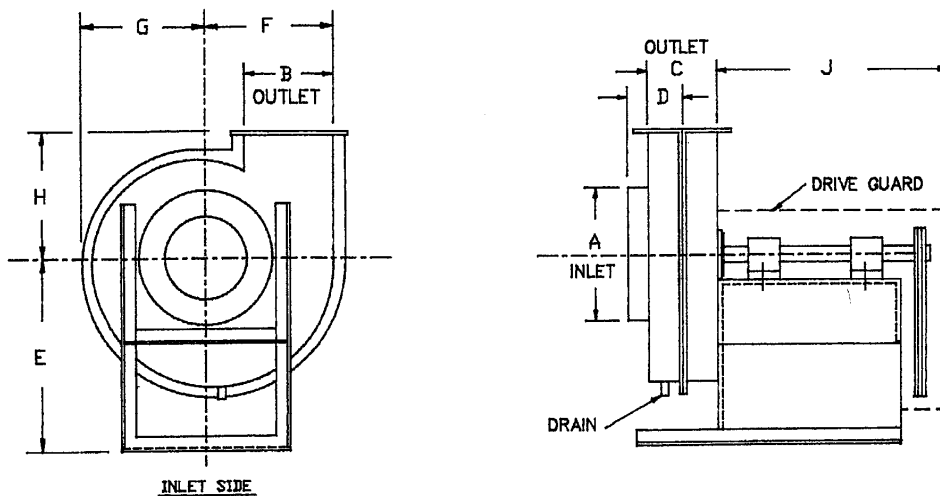

ALL DIMENSIONS IN INCHES

MODEL NO.	12	14	16	18	20	22.5	25	27.5	30	35	40	45	50	55	60
A	12	14	16	18	21	24	27.5	30	32	38	48	54	60	66	72
B	10.5	12.25	14	15.75	18.5	21	24	26	28	33	41.75	47	52.25	57.5	62.75
C	7.375	8.625	9.875	11.125	13	14.75	17	18.5	19.75	23.5	29.5	33.25	37	40.75	44.5
D	6.25	7.25	8.5	9.5	11	12.5	14.5	15.5	17	20	25	28	31	34	37
E	21.75	23	24.5	27	30.5	32	34.5	37	41	45	59	61	66	72	77
F	13.5	16	18	20	24	27	31	33	36	43	54	61	68	74	81
G	12	14	17	18	21	23	27	29	31	36	45	50	56	61	66
H	12	14	16	18	20	21	24	26	29	33.5	42	47	52.5	58	62
J	24	26	28	30	34	34	36	39	39	46	53	56	57	61	65
WHEEL DIA.	15	17.5	20	22.5	26.5	30	34.5	37.5	40	47.5	60	67.5	75	82.5	90



Plasticair Inc.
1275 CRESTLAWN DRIVE,
MISSISSAUGA, ONTARIO, CANADA L4W 1A9
TEL: (905) 625-9164 FAX: (905) 625-0147

Plasticair Inc.
12555 SW FIRST STREET,
BEAVERTON, OREGON, USA 97005
TEL: (503) 672-7086 FAX: (503) 672-9852

email: sales@plasticair.com • Web Page: www.plasticair.com

MODEL 12 MPA

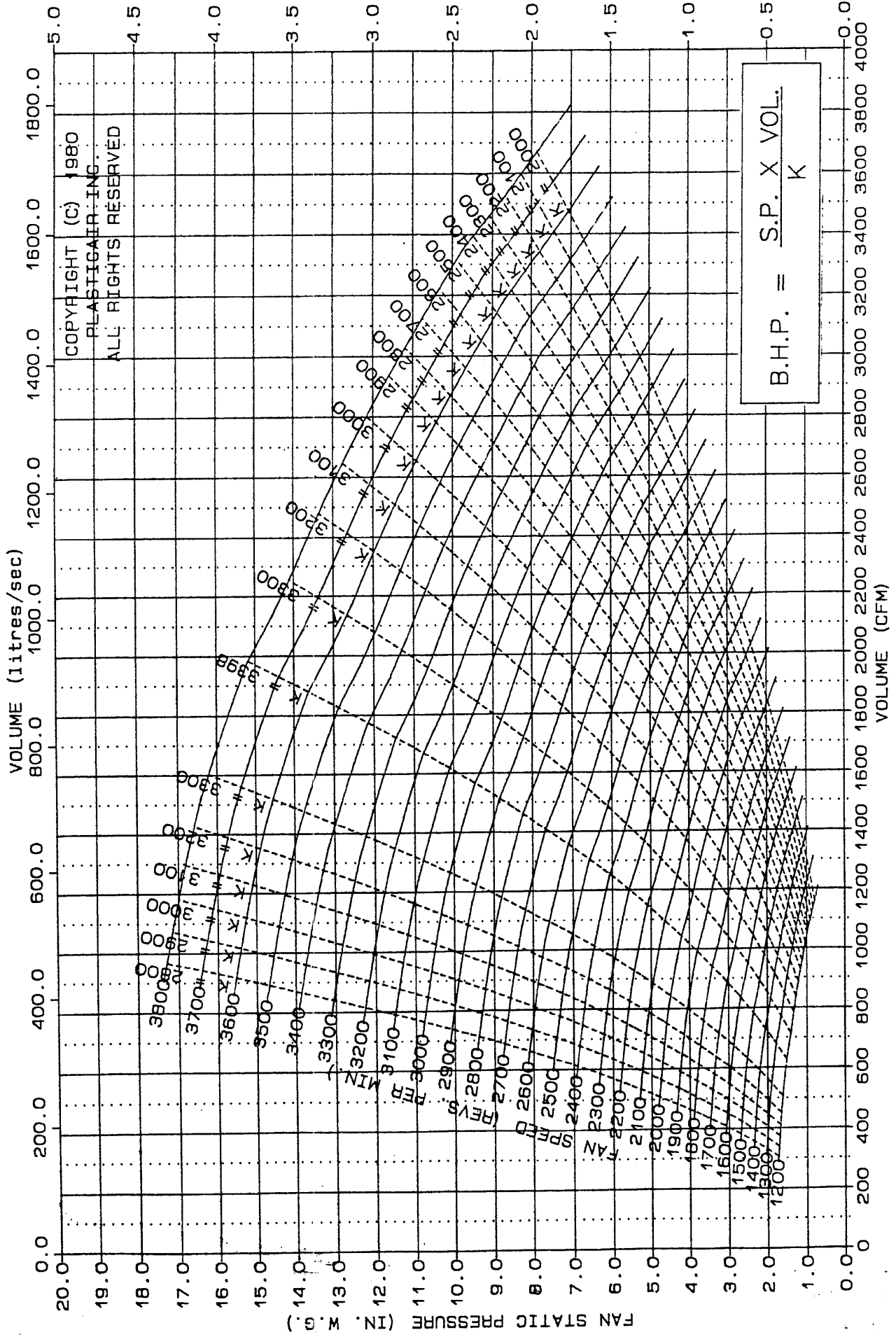

PERFORMANCE SHOWN IS FOR INSTALLATION TYPE B -- FREE INLET, DUCTED OUTLET.
 POWER RATING (BHP) DOES NOT INCLUDE DRIVE LOSSES. PERFORMANCE RATINGS DO NOT INCLUDE THE EFFECTS OF APPURTENANCES IN AIRSTREAM.

MODEL 14 MPA

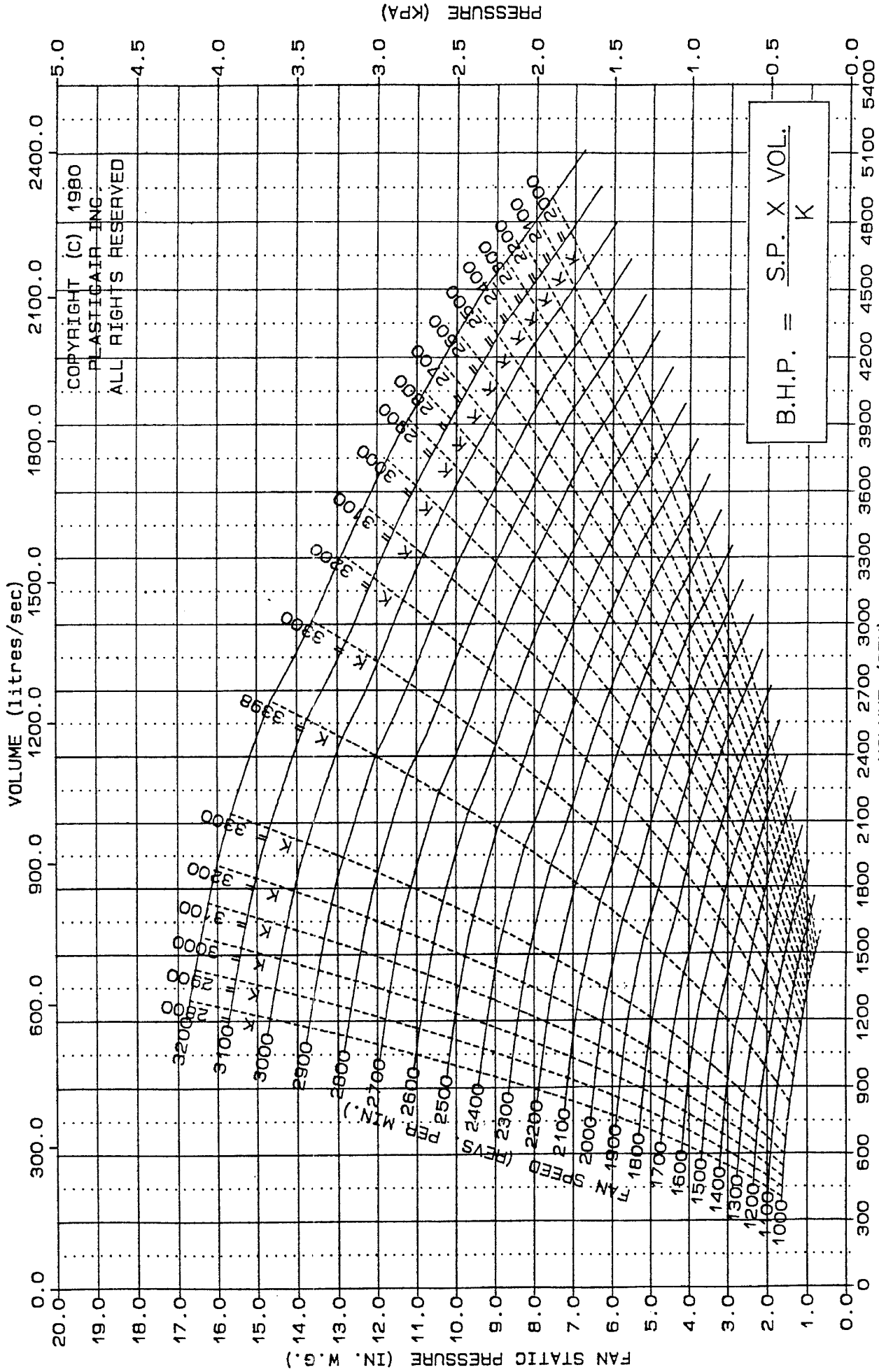

COPYRIGHT (C) 1980
 PLASTIGAIR-INC.
 ALL RIGHTS RESERVED

PERFORMANCE SHOWN IS FOR INSTALLATION TYPE B - FREE INLET, DUCTED OUTLET.
 POWER RATING (BHP) DOES NOT INCLUDE DRIVE LOSSES. PERFORMANCE RATINGS DO NOT INCLUDE THE EFFECTS OF APPURTENANCES IN AIRSTREAM.

MODEL 16 MPA

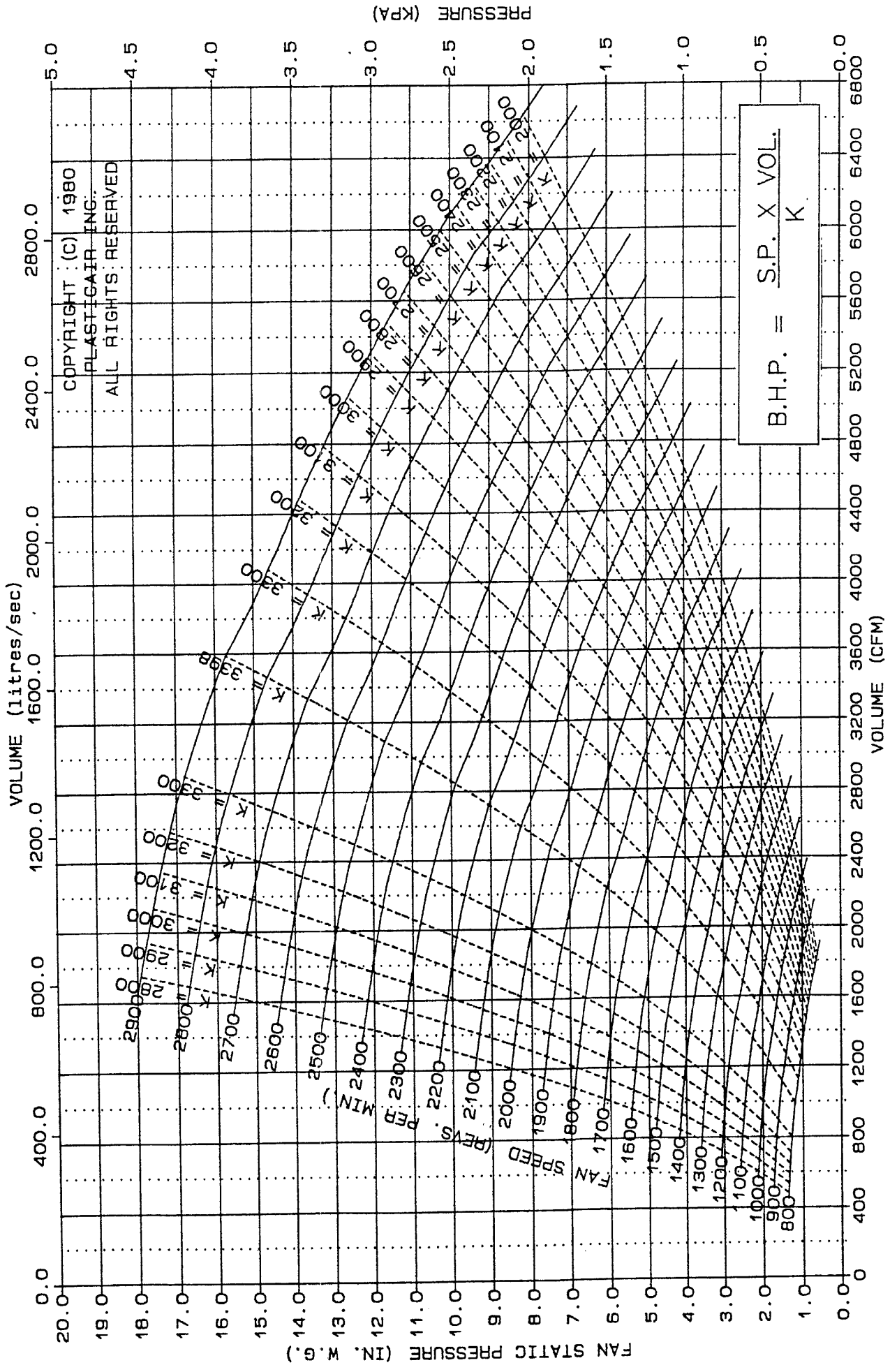

PERFORMANCE SHOWN IS FOR INSTALLATION TYPE B - FREE INLET, DUCTED OUTLET.
 POWER RATING (BHP) DOES NOT INCLUDE DRIVE LOSSES. PERFORMANCE RATINGS DO NOT INCLUDE THE EFFECTS OF APPURTENANCES IN AIRSTREAM.

MODEL 18 MPA

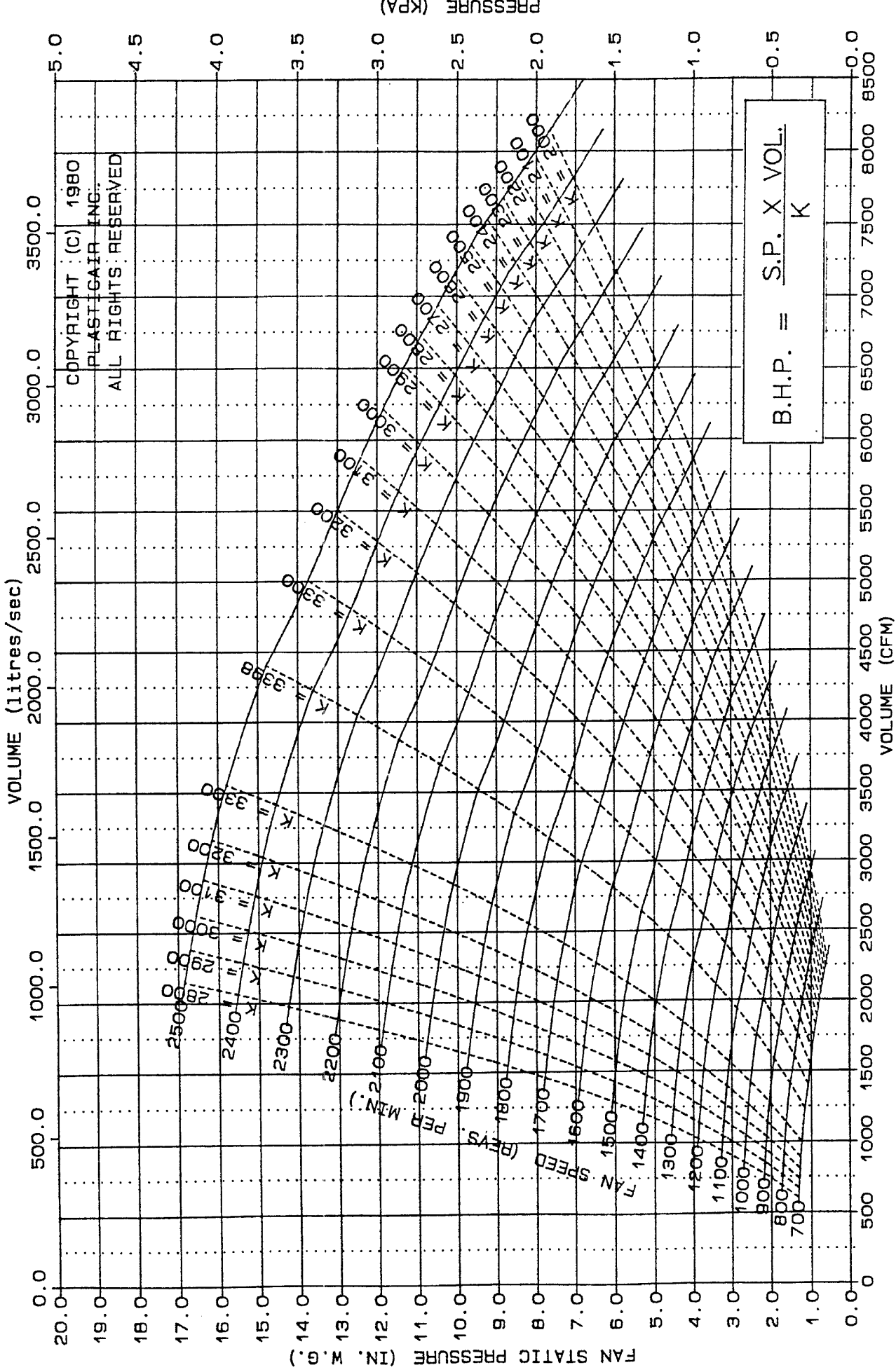

COPYRIGHT (C) 1980
 PLASTIGAIR INC.
 ALL RIGHTS RESERVED

PERFORMANCE SHOWN IS FOR INSTALLATION TYPE B - FREE INLET, DUCTED OUTLET.
 POWER RATING (BHP) DOES NOT INCLUDE DRIVE LOSSES. PERFORMANCE RATINGS DO NOT INCLUDE THE EFFECTS OF APPURTENANCES IN AIRSTREAM.

MODEL 20 MPA

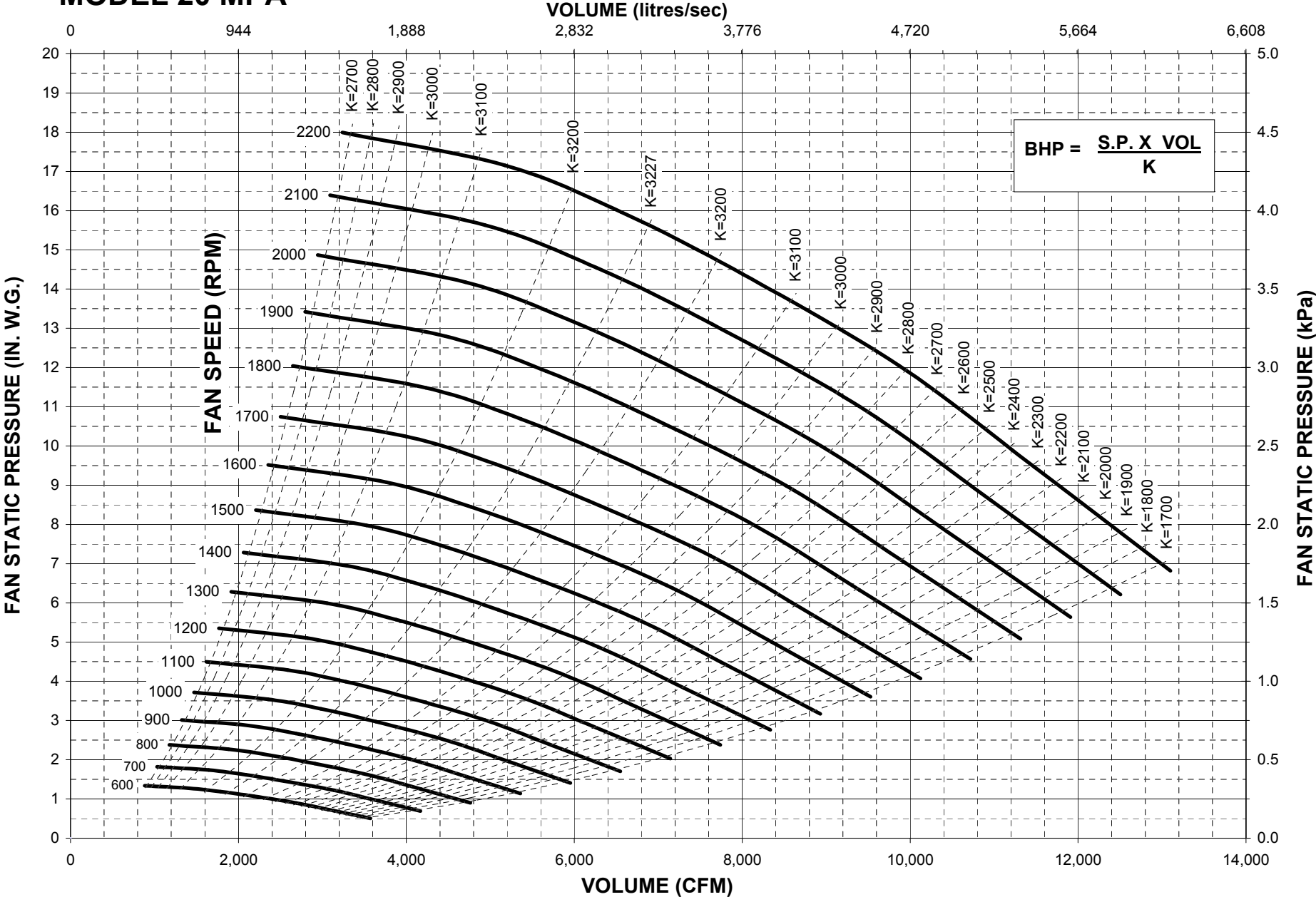

PERFORMANCE SHOWN IS FOR INSTALLATION TYPE B - FREE INLET, DUCTED OUTLET.
POWER RATING (BHP) DOES NOT INCLUDE DRIVE LOSSES. RATINGS DO NOT INCLUDE THE EFFECTS OF APPURTENANCES IN AIRSTREAM.

MODEL 22.5 MPA

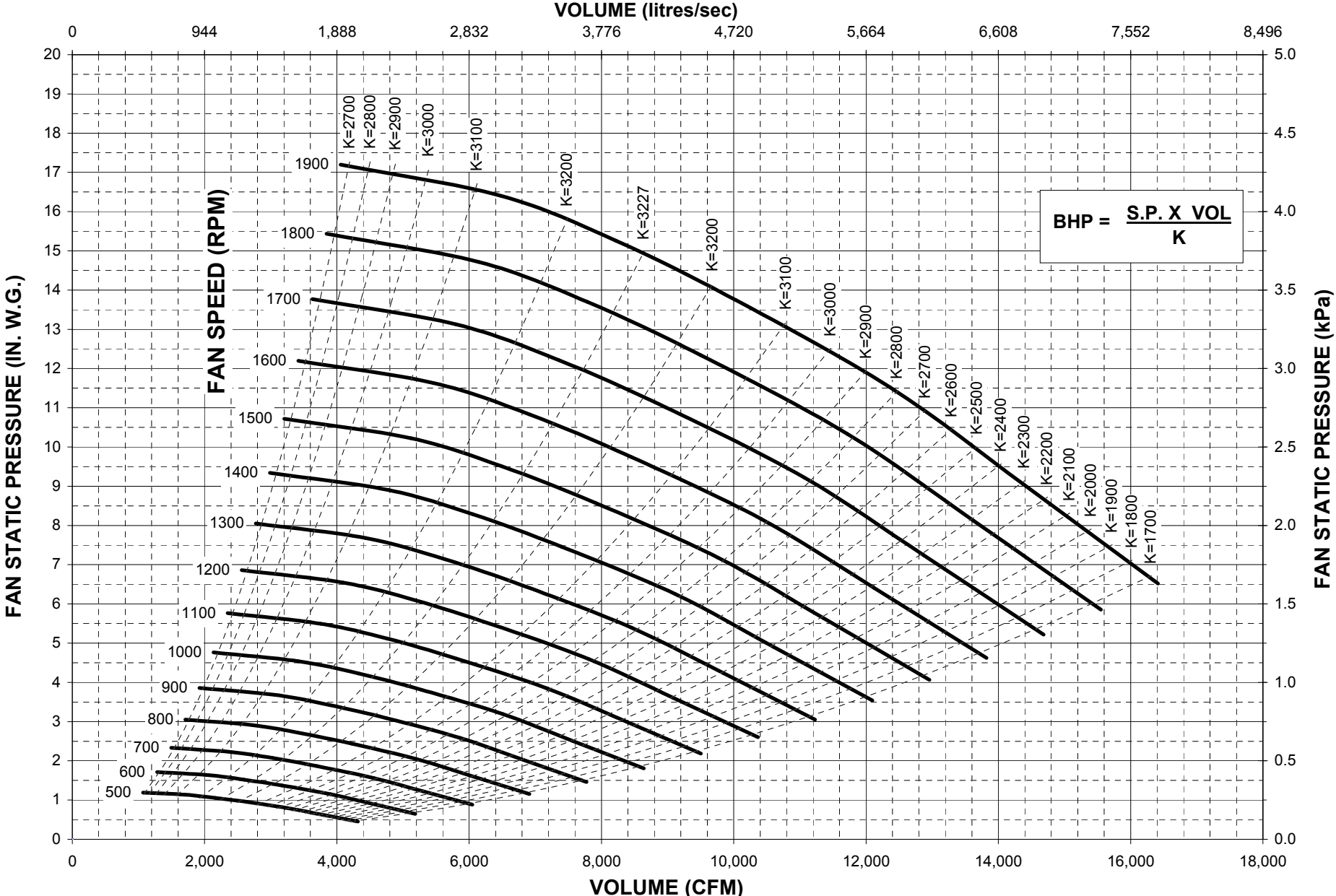

PERFORMANCE SHOWN IS FOR INSTALLATION TYPE B - FREE INLET, DUCTED OUTLET.
 POWER RATING (BHP) DOES NOT INCLUDE DRIVE LOSSES. RATINGS DO NOT INCLUDE THE EFFECTS OF APPURTENANCES IN AIRSTREAM.

MODEL 25 MPA

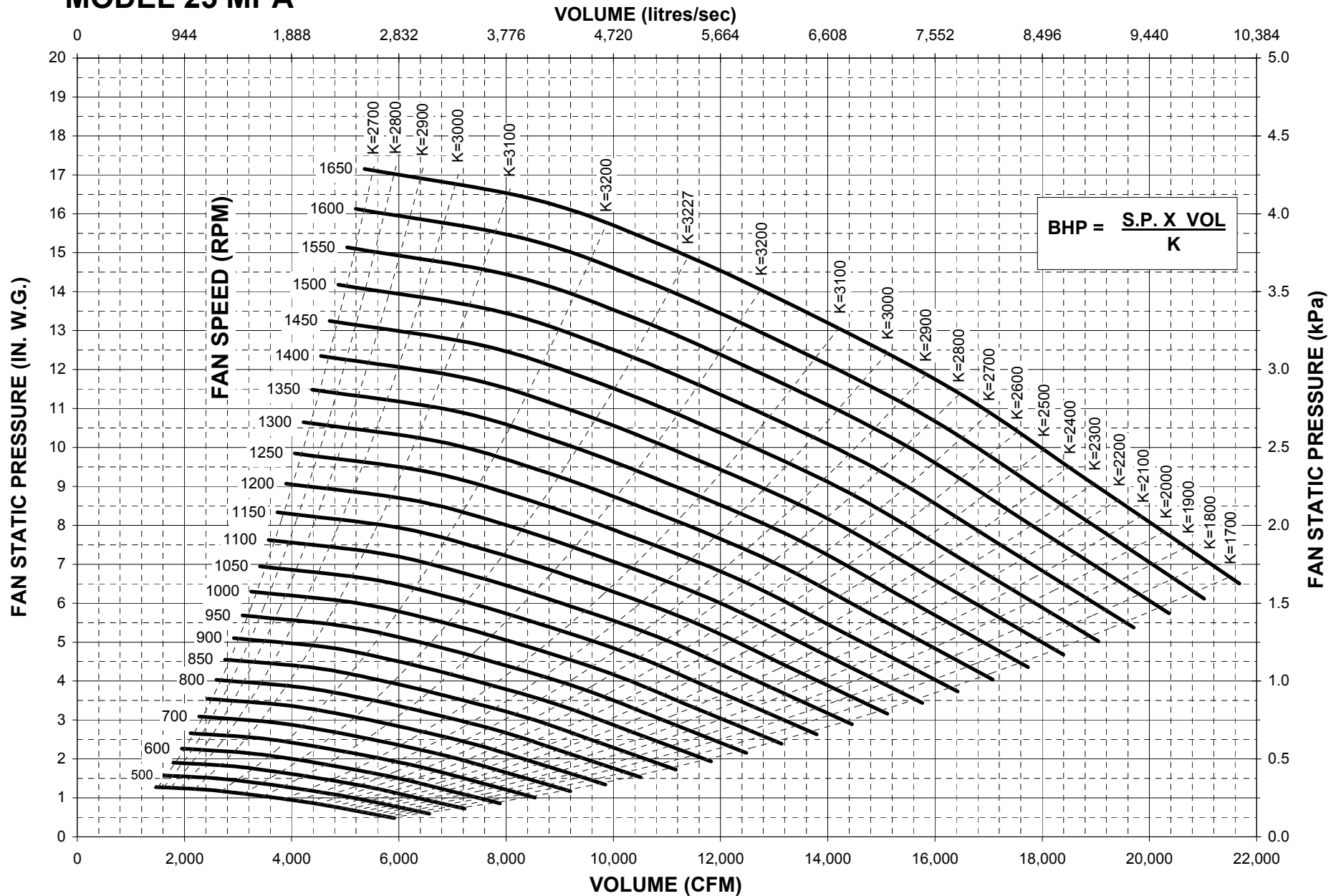

PERFORMANCE SHOWN IS FOR INSTALLATION TYPE B - FREE INLET, DUCTED OUTLET.
POWER RATING (BHP) DOES NOT INCLUDE DRIVE LOSSES. RATINGS DO NOT INCLUDE THE EFFECTS OF APPURTENANCES IN AIRSTREAM.

MODEL 27.5 MPA

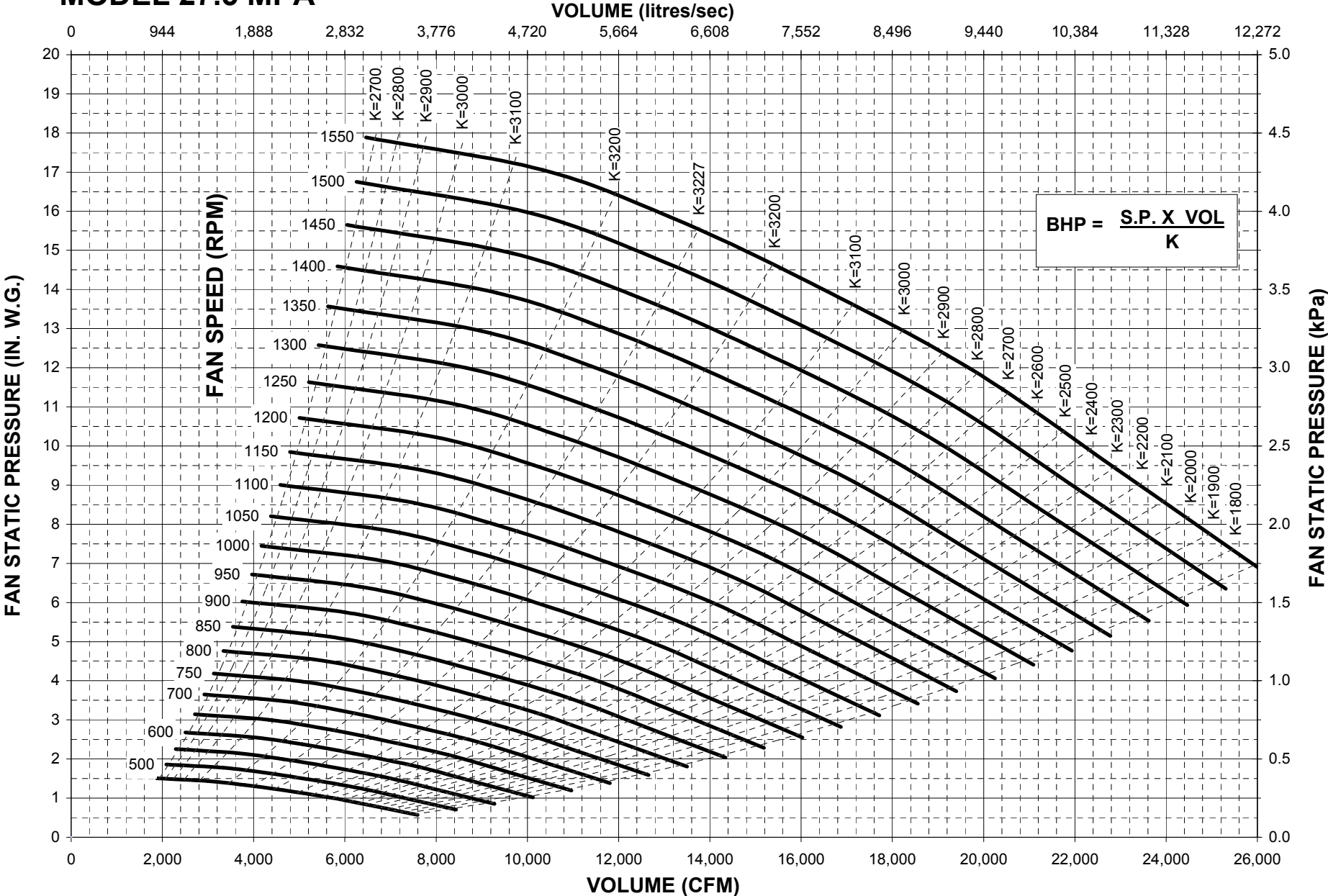

PERFORMANCE SHOWN IS FOR INSTALLATION TYPE B - FREE INLET, DUCTED OUTLET.
 POWER RATING (BHP) DOES NOT INCLUDE DRIVE LOSSES. RATINGS DO NOT INCLUDE THE EFFECTS OF APPURTENANCES IN AIRSTREAM.

MODEL 30 MPA

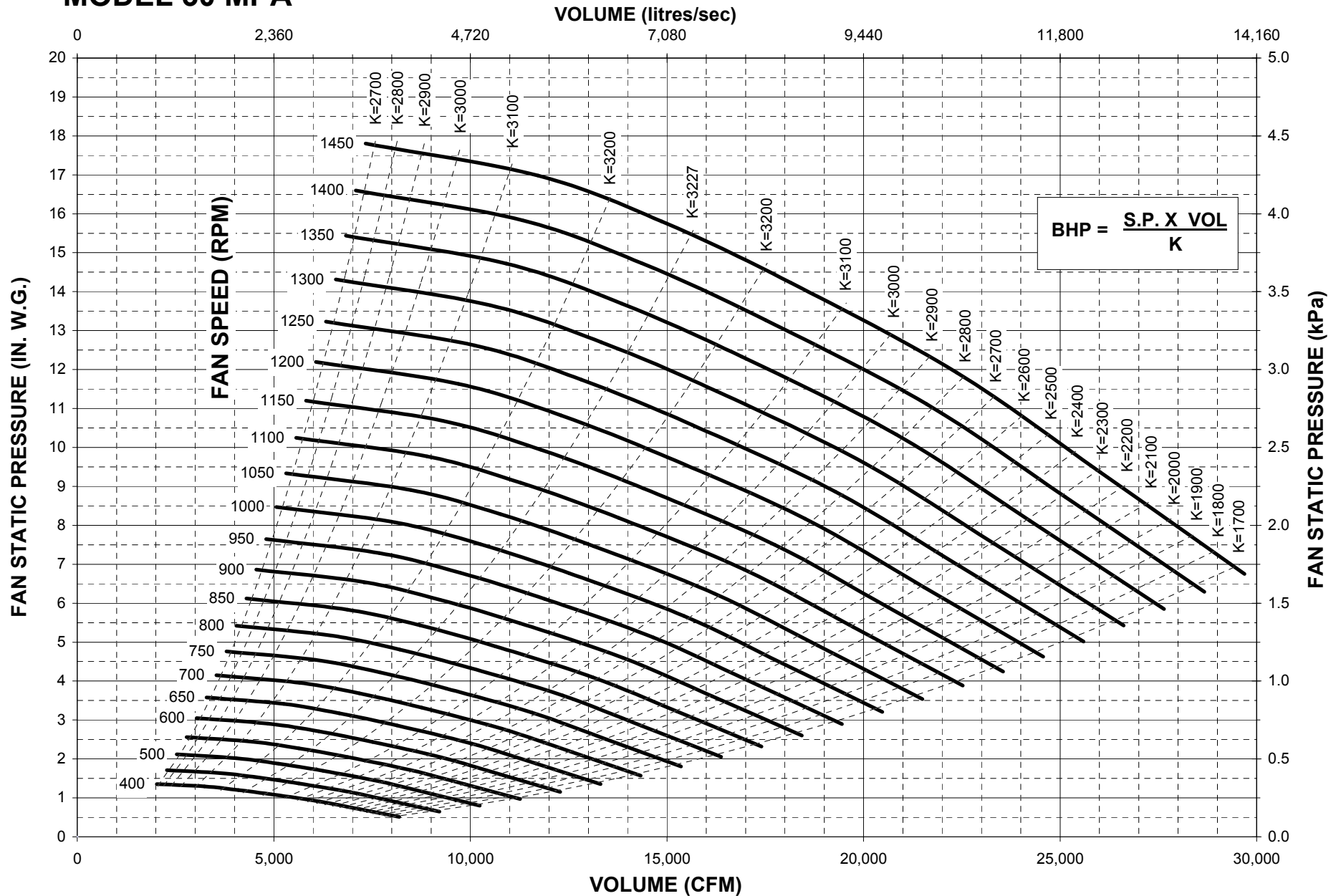

PERFORMANCE SHOWN IS FOR INSTALLATION TYPE B - FREE INLET, DUCTED OUTLET.
POWER RATING (BHP) DOES NOT INCLUDE DRIVE LOSSES. RATINGS DO NOT INCLUDE THE EFFECTS OF APPURTENANCES IN AIRSTREAM.

MODEL 35 MPA

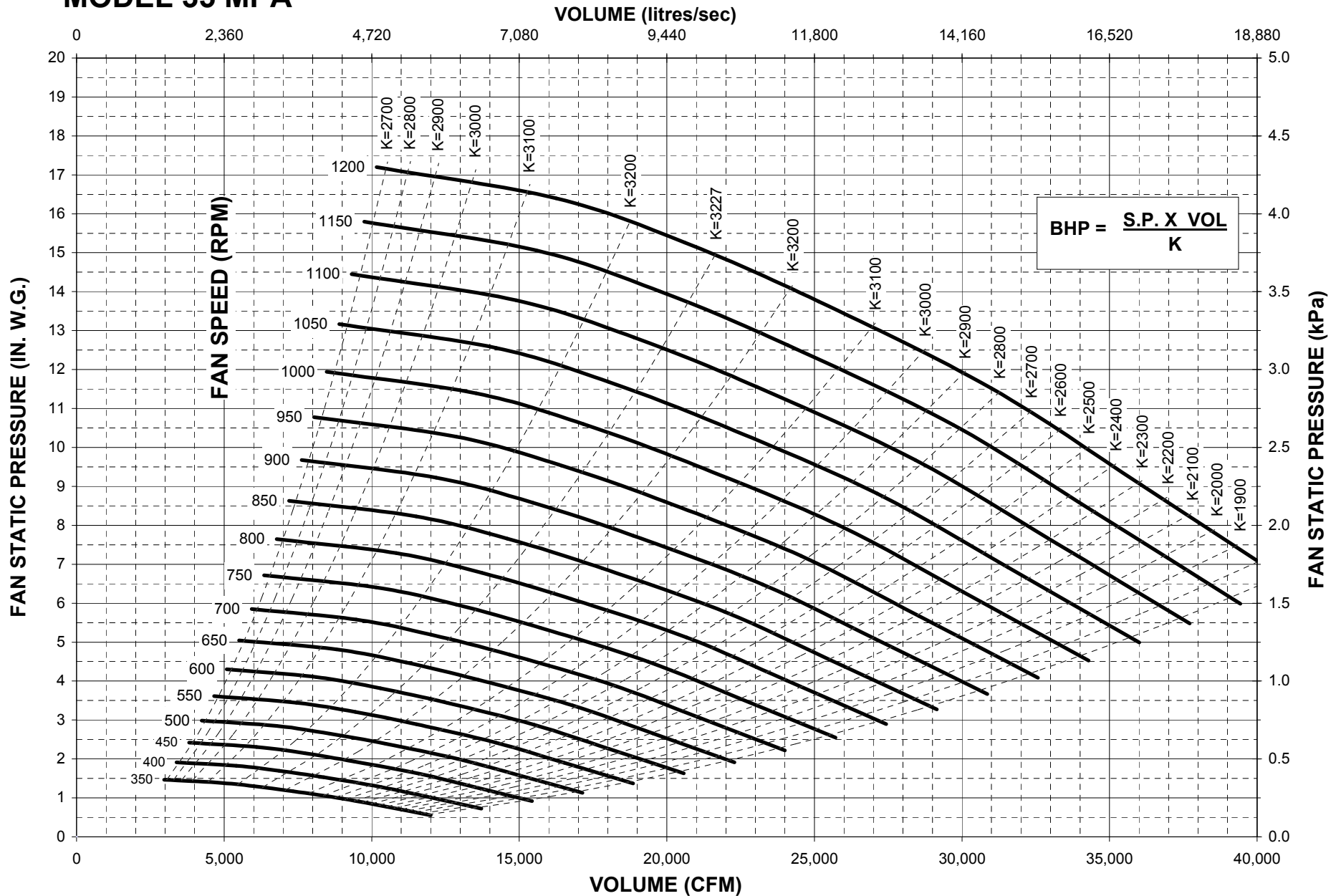

PERFORMANCE SHOWN IS FOR INSTALLATION TYPE B - FREE INLET, DUCTED OUTLET.
POWER RATING (BHP) DOES NOT INCLUDE DRIVE LOSSES. RATINGS DO NOT INCLUDE THE EFFECTS OF APPURTENANCES IN AIRSTREAM.

MODEL 40 MPA

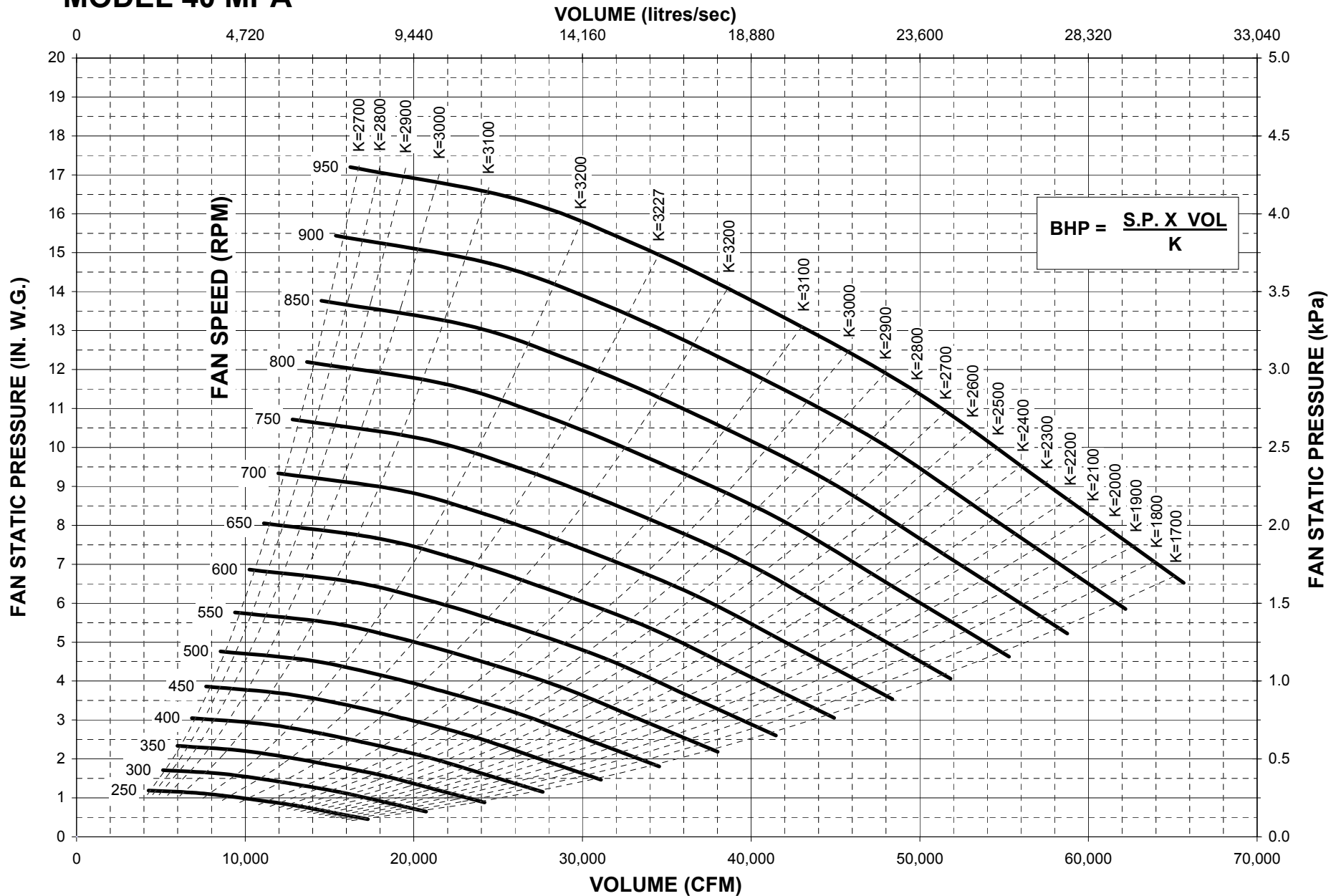

PERFORMANCE SHOWN IS FOR INSTALLATION TYPE B - FREE INLET, DUCTED OUTLET.
POWER RATING (BHP) DOES NOT INCLUDE DRIVE LOSSES. RATINGS DO NOT INCLUDE THE EFFECTS OF APPURTENANCES IN AIRSTREAM.

MODEL 45 MPA

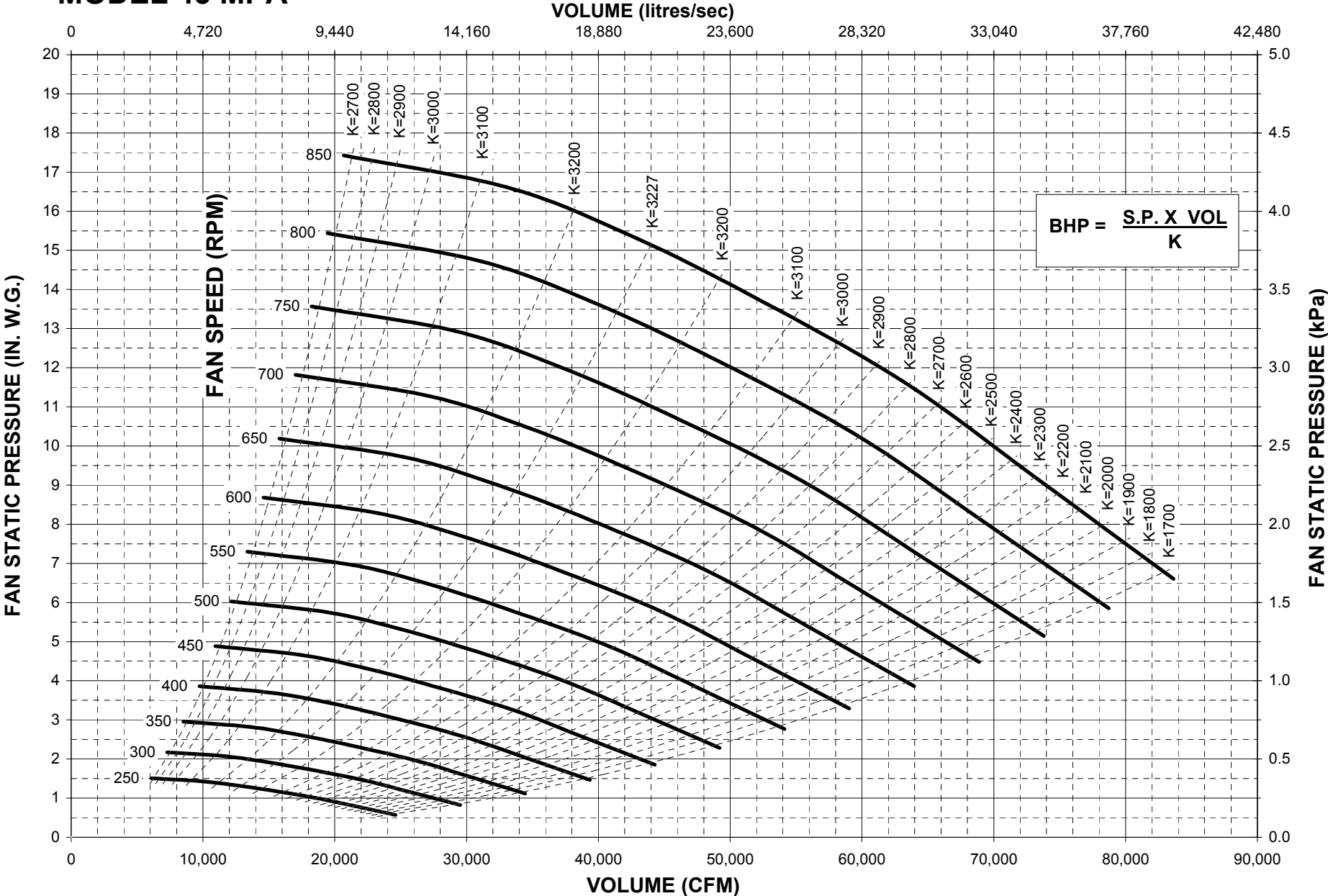

PERFORMANCE SHOWN IS FOR INSTALLATION TYPE B - FREE INLET, DUCTED OUTLET.
 POWER RATING (BHP) DOES NOT INCLUDE DRIVE LOSSES. RATINGS DO NOT INCLUDE THE EFFECTS OF APPURTENANCES IN AIRSTREAM.

MODEL 50 MPA

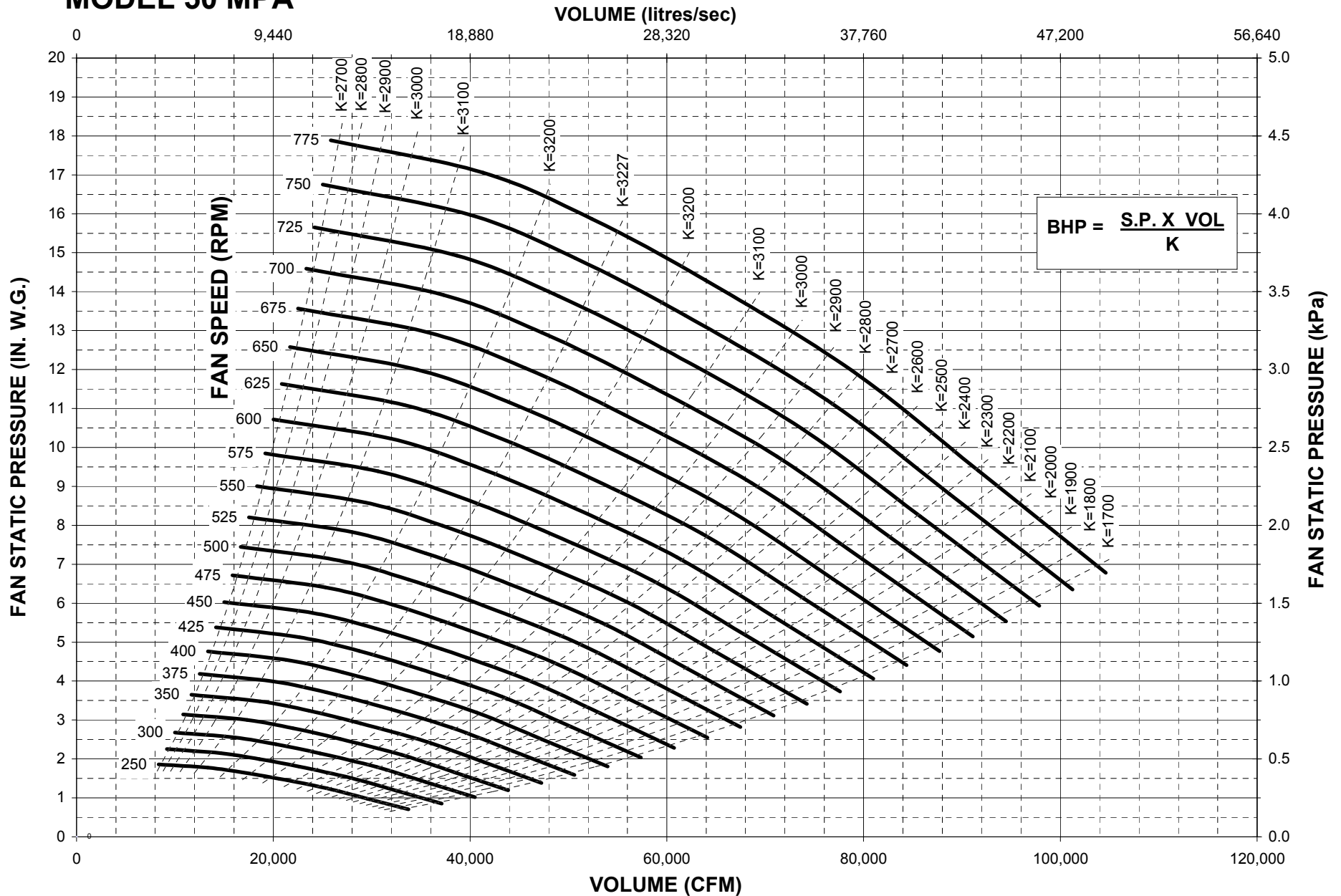

PERFORMANCE SHOWN IS FOR INSTALLATION TYPE B - FREE INLET, DUCTED OUTLET.
POWER RATING (BHP) DOES NOT INCLUDE DRIVE LOSSES. RATINGS DO NOT INCLUDE THE EFFECTS OF APPURTENANCES IN AIRSTREAM.

MODEL 55 MPA

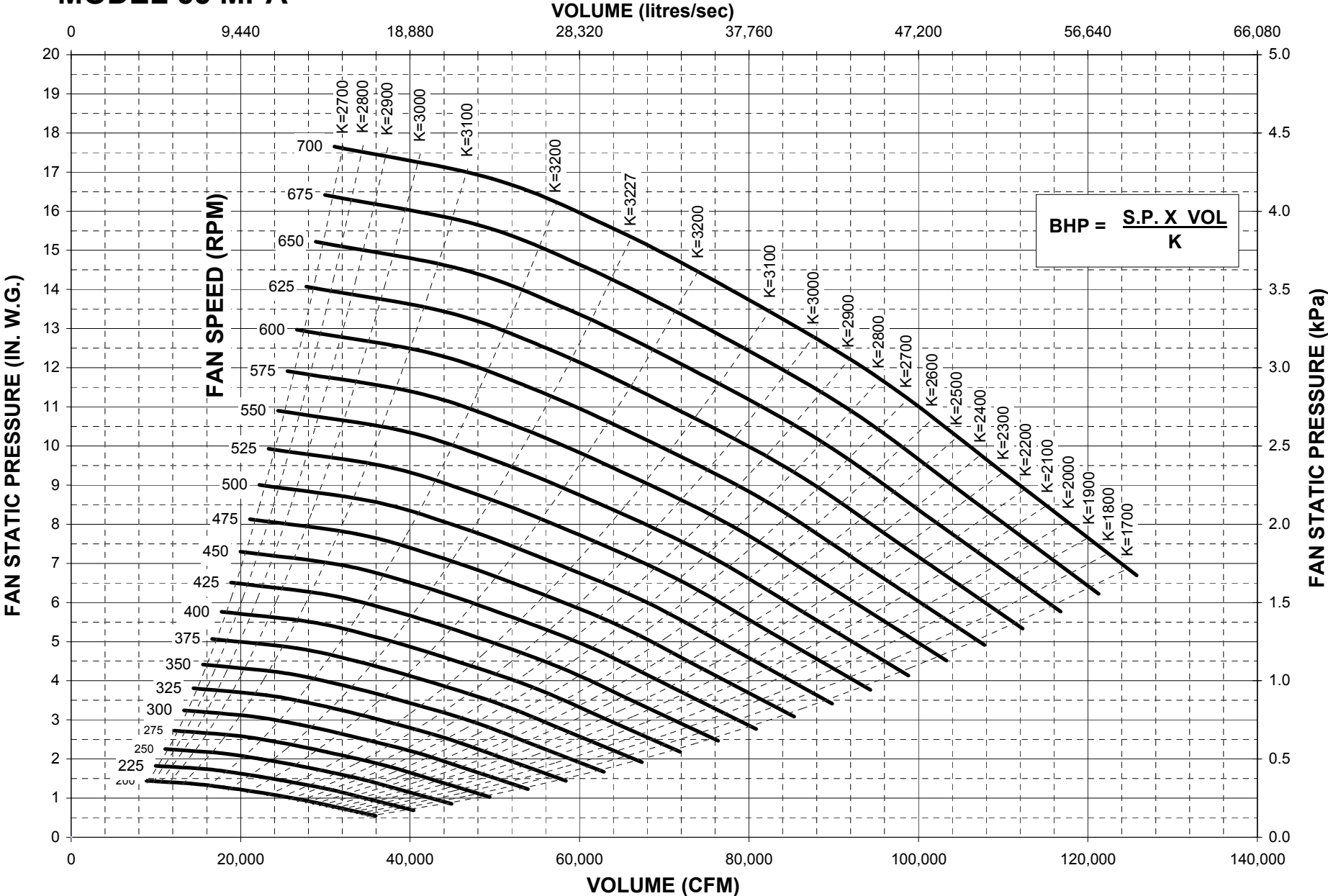

PERFORMANCE SHOWN IS FOR INSTALLATION TYPE B - FREE INLET, DUCTED OUTLET.
POWER RATING (BHP) DOES NOT INCLUDE DRIVE LOSSES. RATINGS DO NOT INCLUDE THE EFFECTS OF APPURTENANCES IN AIRSTREAM.

MODEL 60 MPA

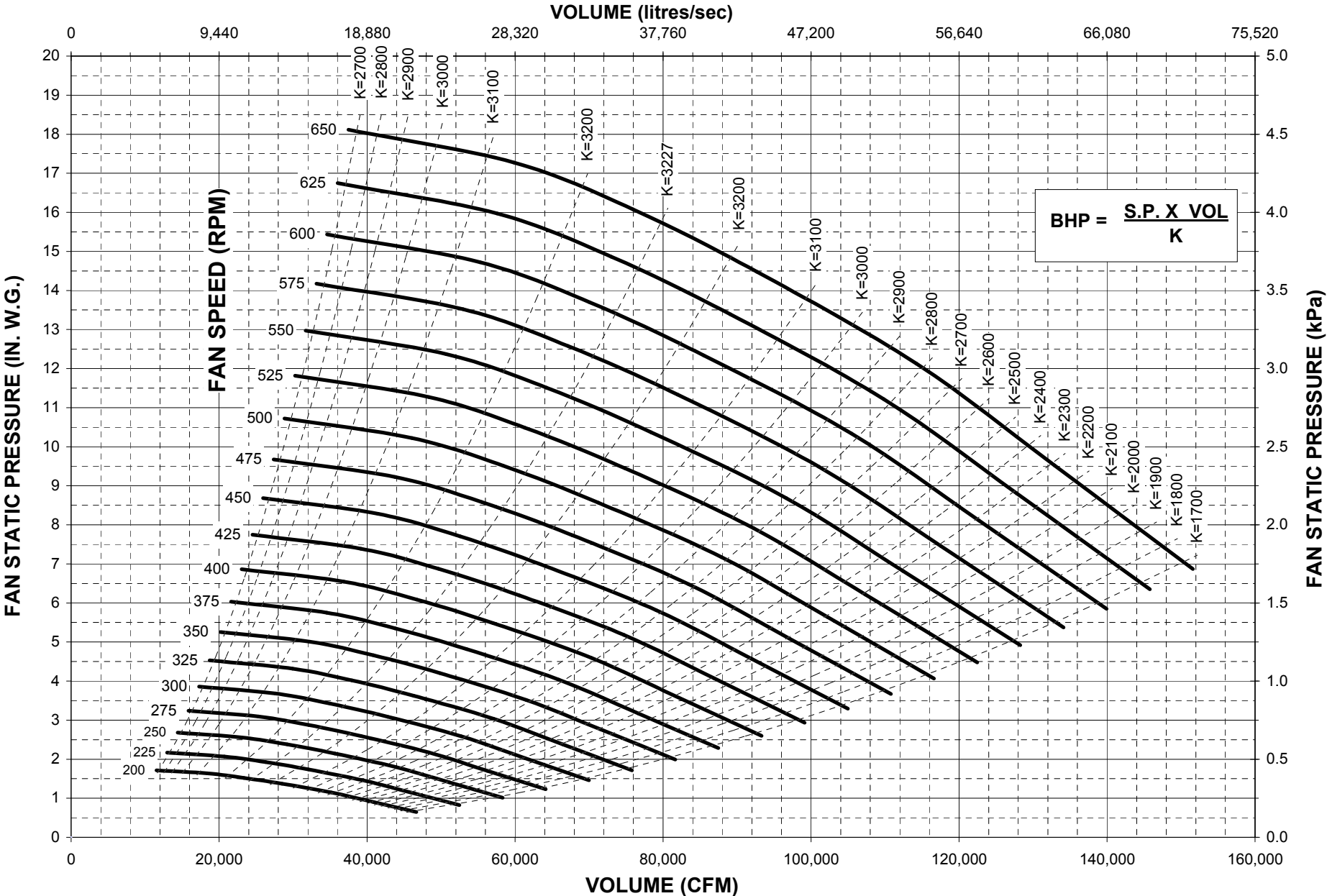

PERFORMANCE SHOWN IS FOR INSTALLATION TYPE B - FREE INLET, DUCTED OUTLET.
 POWER RATING (BHP) DOES NOT INCLUDE DRIVE LOSSES. RATINGS DO NOT INCLUDE THE EFFECTS OF APPURTENANCES IN AIRSTREAM.